

GRIP! S

Pendant light, PHASE, pendant length 200 cm, 3000 K, 29°, gold / black

GRIP! - the striking light family for sophisticated lighting design. With its distinctive knurled front ring and many new pendant, surface-mounted and recessed options, GRIP! now offers even more options for customised lighting concepts. The honeycomb louvre insert supplied as standard reduces glare and ensures optimum visual comfort. Different colours and designs blend harmoniously into living spaces, hotels or restaurants. High-quality technology with a CRI of 90, a lifetime of 50,000 hours and easy installation make GRIP! an all-round convincing choice.

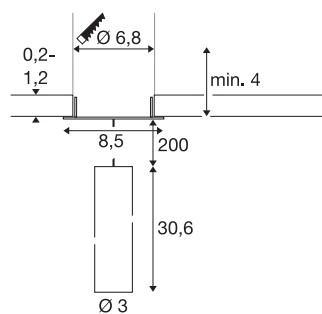

TECHNICAL DATA

Item no.	1009067
Number of different light outlets	1
IP Code	IP20
Impact resistance class	IK 02
Impact resistance	0.2 Joule
Assembly	Recessed
Assembly details	Ceiling
Dimmable	Yes
Dimming technology	Leading edge, trailing edge
Primary nominal voltage	220-240V ~50/60 Hz
Secondary power / voltage	250 mA
Safety class	II
Wattage	10 W
Minimum ambient temperature	0 °C
Maximum ambient temperature	35 °C
Number of luminaires at LS B16A	224
Number of luminaires at LS C16A	228
Level of inrush current	5 A
Duration of inrush current	100 µs
Lumen	620 lm
Colour temperature	3000 Kelvin
Beam angle	29 °

Light Source

2093886	
---------	---

Accessories

1008489	GRIP! S , decorative ring, black
1008488	GRIP! S , decorative ring, white
1008490	GRIP! S , decorative ring, nickel
1008491	GRIP! S , decorative ring, gold

Color	gold/black
CRI	90
UGR \leq	25
Service life	50000 h
Risk Group	1
Height	30.6 cm
Diameter	3 cm
Pendant length	200 cm
Net weight	0.402 kg
Gross weight	0.598 kg
Shape of cut-out	round
Installation depth	4 cm
Installation diameter	6.8 cm
BIG WHITE Page	209